

HITACHI

# *SuperEX* **V** **EX60**

Rated Engine HP : 41 kW ( 55 PS )

Operating Weights

EX60-5 : 6 300 kg ( 13 900 lb )

EX60LC-5 : 6 390 kg ( 14 100 lb )

Bucket Capacity

PCSA Heaped : 0.11—0.34 m<sup>3</sup> ( 0.14 — 0.44 yd<sup>3</sup> )

CECE Heaped : 0.10—0.30 m<sup>3</sup>



# The Quest for Real Value: The Super EX-V

Technological advances are limitless. The quest for real value—That's Hitachi's new challenge. The result is the Super EX-V, featuring responsiveness of human-touch control with feel of power, agile movements, operator-first cab, enlarged undercarriage stability and mobility, plus highly durable front and undercarriage components. The environmentally-friendly design fits comfortably into a wide range of applications including civil engineering, pipe-laying work, demolition, and chizan work. The Super EX-V is the productive, powerful hydraulic excavator that reduces lifetime costs. The advent of the Hitachi hydraulic excavator with real value... just the beginning of Hitachi's next stride forward.

## Super EX-V EX60



The EX60-s fitted with 3.72m (12'2") boom, 1.62m (5'4") arm and 0.28 m<sup>3</sup> (0.37 yd<sup>3</sup>) bucket

# Quick-Responding Control Enhances Easy, Productive Operation

### 1 The Advanced Hydraulic System — a Hitachi original — the Heart of the Super EX-V

Here's versatility...a phase of real value. The advanced hydraulic system provides impressive versatility, allowing a variety of operations, such as digging, grading, finishing, and materials handling, with power and speed.

This hydraulic system provides:

- Smooth operations.
- Matched combined operations.
- Reduces operator fatigue.

In other words, the Super EX-V delivers superior combined operations, quick level finishing, nimble slope tamping, and simple positioning for demolition, as well as straight-line travel and accurate steering

#### Level Finishing

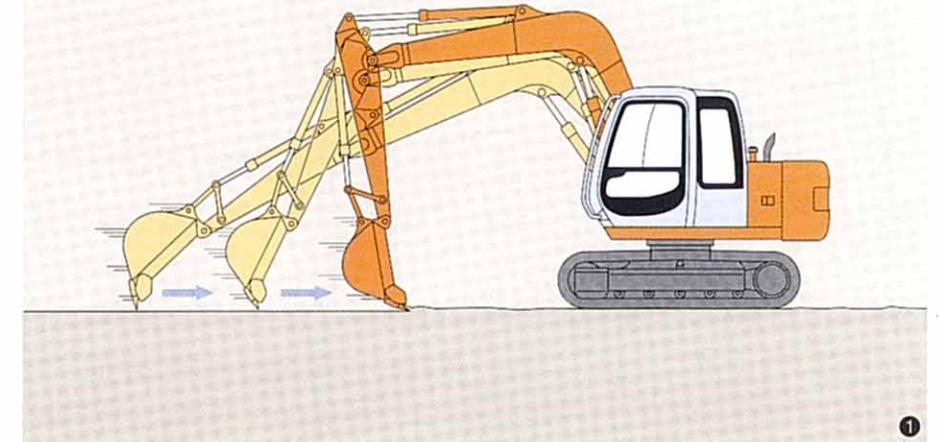

- Increased finishing speed

#### Slope Finishing

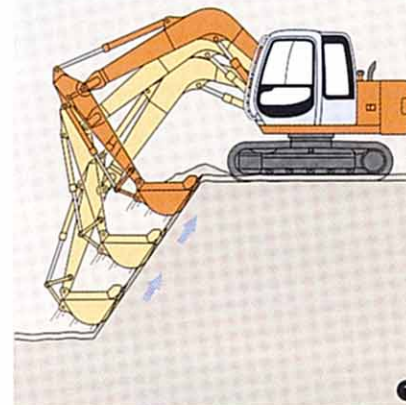

- Agile front movements

#### Front+Travel

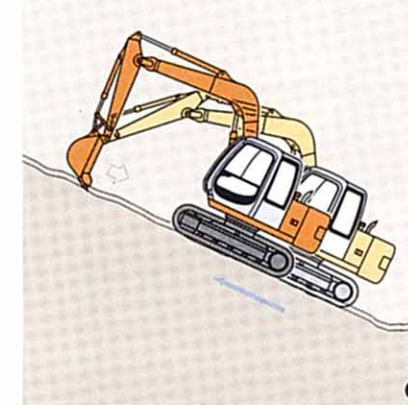

- Powerful slope climbing

#### Tamping

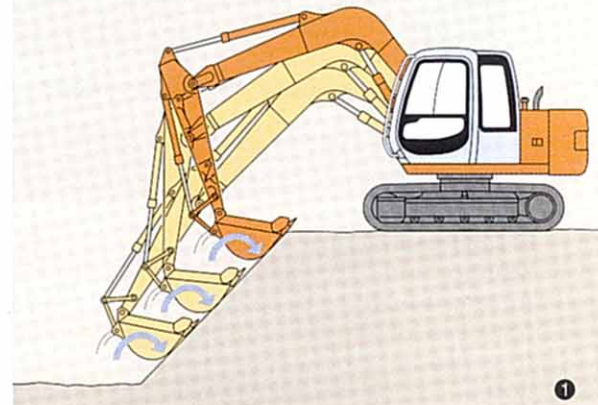

- Quick, dynamic movements

### 2 Bigger Digging Forces

Powerful, efficient digging with bigger digging forces.

- Arm digging force : 38.2 kN ( 3 900 kgf, 8 600 lbf )
- Bucket digging force : 54.9 kN ( 5 600 kgf, 12 350 lbf )

### 2 Boosted Job Efficiency in E Mode

Engine speed is reduced in the E mode. Here, swashplate angle is computer controlled to increase pump delivery oil flow. This increases fuel efficiency.

### 2 Auto Idle Provided Standard

With the auto idle switch on, when the control lever is shifted to neutral, engine speed is reduced automatically about four seconds later. This saves energy.

### 3 Increased Traction Force for Higher Mobility

Traction force is increased by 7%, and front idlers are enlarged diameter for higher mobility — powerful fast-speed travel.

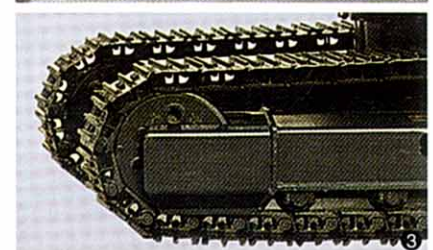

# Operator Comfort Creates Higher Productivity

## 1 Roomy Cab with Superior Visibility

The operator's cab is spacious, with ample space for legs. The retractable wiper and large overhead window help increase visibility.



## 2 Comfort Designed Seat

The operator seat can be adjusted to operator's build and type of job. Vinylcovered seat eases cleaning.



### Adjustments:

- ① Seat sliding lever (back-and-forth)
- ② Reclining lever
- ③ Headrest height
- ④ Control lever height [35mm (1.38") range]
- ⑤ Pilot control shut-off lever
- Seat height (bolt resetting)

## 3 Rational Controls Layout

Monitor and switches are grouped functionally to the right of the seat for ease of operation. Dial-type fuel throttle enhances easy operation.



## 4 6 Fluid-Filled Elastic Mounts

Cab shocks and vibration are dampened with 6 fluid-filled elastic mounts in place of a conventional 4-point mount. This reduces operator's fatigue.

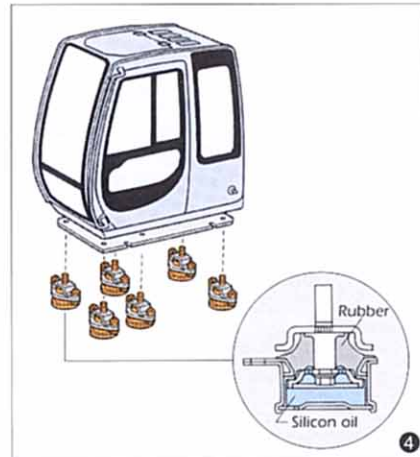

## 5 Adjustable Lever Height

Control lever height can be adjusted in three stages [full 35 mm (1.38") range].

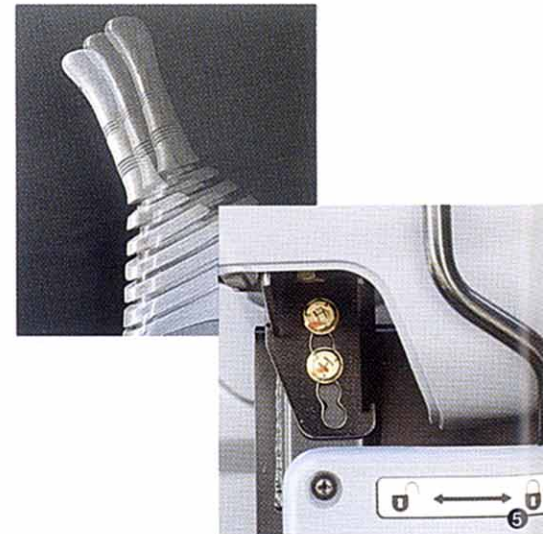

# Operator-and Environmentally-Friendly Design Enhances Simplified Maintenance and Reliability

## 1 Low Noise Design

The newly developed muffler reduces noise for quiet operation.

- Noise Level at Operator's ear: 70 dB (A)
- Noise Level at 7 m (23'0") away: 68 dB (A)

## 2 Evacuation Tool and Large Overhead Window

An evacuation tool is provided for emergency evacuation. A large overhead window can be used as an emergency exit.

## 3 Easy Maintenance Permitted by HN Bushings

The HN bushings are made of a sintered composite iron alloy with high-viscosity lubricating oil vacuum impregnated in micron-sized pores. They are carburized for reliable and durable.

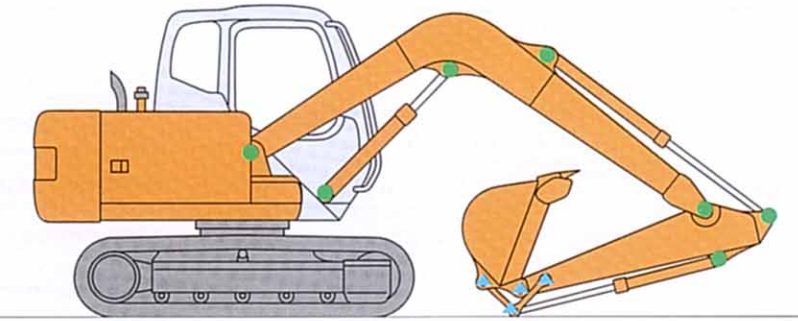
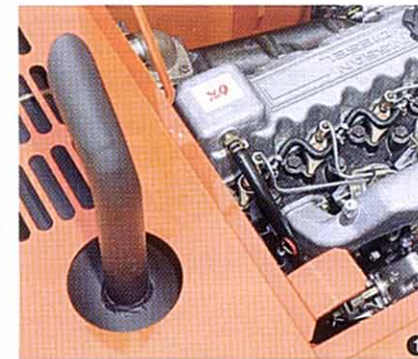

Interval ●: 500 hours ▲: 100 hours

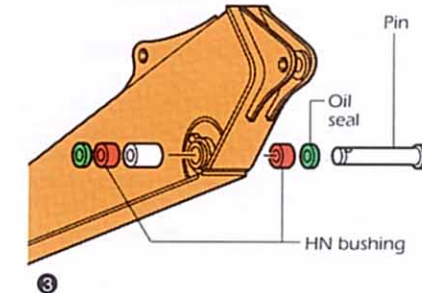

### Principle of HN bushing

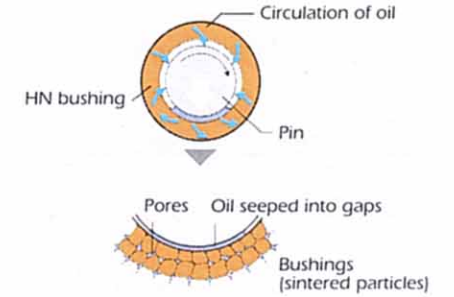

## 4 Enhanced Durability

Durability is further enhanced by widening arm top width and increasing pin diameter. Also, track frame, travel motor cover and track adjuster are strengthened for durability.

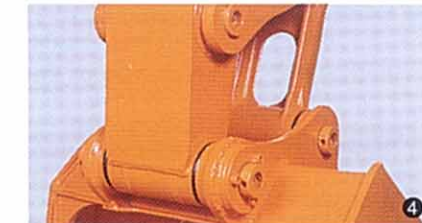

● Arm and Bucket pin

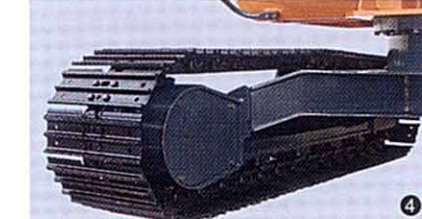

● Round travel motor cover



● Emergency engine stop lever (below seat)

## 5 Pump Bulkhead

A bulkhead is provided between pump and engine.

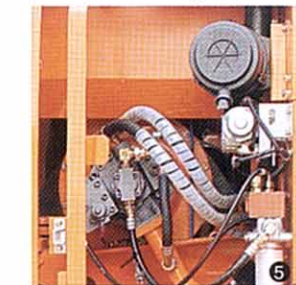

● Large handrail



## DIMENSIONS

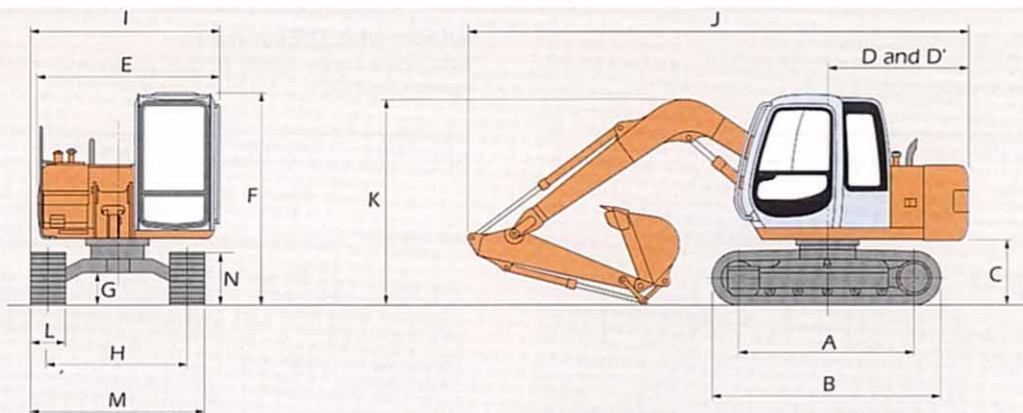

	EX60-s/EX60LC-s		EX60-s/EX60LC-s with Rubber crawler	
	STD	LC	STD	LC
A Distance between tumbler	2 140 mm (7'0")	2 290 mm (7'6")	2 140 mm (7'0")	2 290 mm (7'6")
B Undercarriage length	2 765 mm (8'10")	2 920 mm (9'7")	2 765 mm (8'10")	2 920 mm (9'7")
*C Counterweight clearance	760 mm (2'6")		780 mm (2'7")	
D Rear-end swing radius	1 750 mm (5'9")		1 750 mm (5'9")	
D' Rear-end length	1 750 mm (5'9")		1 750 mm (5'9")	
E Overall width of upperstructure	2 255 mm (7'5")		2 255 mm (7'5")	
F Overall height of cab	2 570 mm (8'5")		2 570 mm (8'5")	
*G Min. ground clearance	360 mm (1'2")		380 mm (1'3")	
H Track gauge	STD 1 750 mm (5'9")	LC 1 850 mm (6'1")	STD 1 750 mm (5'9")	LC 1 850 mm (6'1")
I Overall width	STD 2 340 mm (7'8")	LC 2 390 mm (7'10")	STD 2 340 mm (7'8")	LC 2 390 mm (7'10")
J Overall length				
With 1.62 m (5'4") arm	6 080 mm (19'11")		6 080 mm (19'11")	
With 2.12 m (6'11") arm	6 120 mm (20'1")		6 120 mm (20'1")	
K Overall height of boom				
With 1.62 m (5'4") arm	2 550 mm (8'4")		2 550 mm (8'4")	
With 2.12 m (6'11") arm	2 880 mm (9'5")		2 880 mm (9'5")	
L Track shoe width	G: 450 mm (18")	G: 600 mm (24")	R: 450 mm (18")	
M Undercarriage width	STD 2 200 mm (7'3")	LC 2 350 mm (7'9")	2 200 mm (7'3")	2 300 mm (7'7")
N Track height	670 mm (2'2") with triple grouser shoe		670 mm (2'2") with rubber crawler	

\*Excluding track shoe lug.  
(Except the rubber crawler)

G: Triple grouser shoe

R: Rubber crawler

## WORKING RANGES

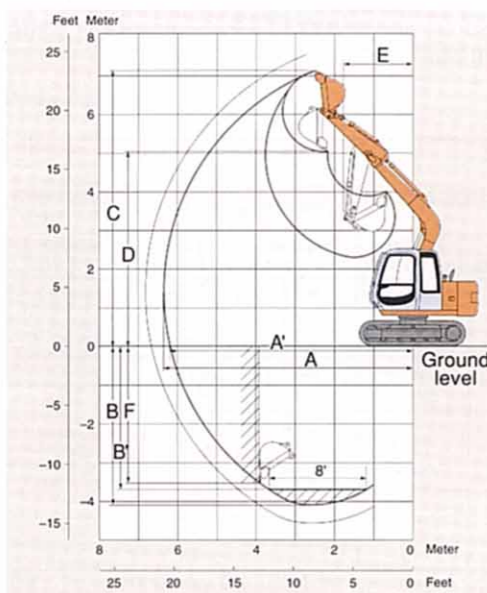

Arm length	EX60-s/EX60LC-s		EX60-s/EX60LC-s with Rubber crawler	
	1.62 m (5'4")	2.12 m (6'11")	1.62 m (5'4")	2.12 m (6'11")
A Max. digging reach	6 310 mm (20'8")	6 800 mm (22'4")	6 310 mm (20'8")	6 800 mm (22'4")
A' Max. digging reach (on ground)	6 160 mm (20'3")	6 660 mm (21'10")	6 160 mm (20'3")	6 660 mm (21'10")
B Max. digging depth	4 150 mm (13'7")	4 660 mm (15'3")	4 130 mm (13'7")	4 640 mm (15'3")
B' Max. digging depth (8' level)	3 800 mm (12'6")	4 370 mm (14'4")	3 780 mm (12'5")	4 350 mm (14'3")
C Max. cutting height	7 150 mm (23'5")	7 550 mm (24'9")	7 170 mm (23'6")	7 570 mm (24'10")
D Max. dumping height	5 070 mm (16'8")	5 470 mm (17'11")	5 090 mm (16'8")	5 490 mm (18'0")
E Min. swing radius	1 700 mm (5'7")	2 060 mm (6'9")	1 700 mm (5'7")	2 060 mm (6'9")
F Max. vertical wall	3 520 mm (11'7")	4 060 mm (13'4")	3 480 mm (11'5")	4 040 mm (13'3")
Bucket digging force	ISO 55 kN (5 600 kgf, 12 400 lbf)		ISO 55 kN (5 600 kgf, 12 400 lbf)	
force	SAE, PCSA 47 kN (4 800 kgf, 10 600 lbf)		SAE, PCSA 47 kN (4 800 kgf, 10 600 lbf)	
Arm crowd force	ISO 38 kN (3 900 kgf, 8 600 lbf)	32 kN (3 300 kgf, 7 280 lbf)	38 kN (3 900 kgf, 8 600 lbf)	32 kN (3 300 kgf, 7 280 lbf)
	SAE, PCSA 36 kN (3 700 kgf, 8 200 lbf)	31 kN (3 200 kgf, 7 100 lbf)	36 kN (3 700 kgf, 8 200 lbf)	31 kN (3 200 kgf, 7 100 lbf)

## DIMENSIONS

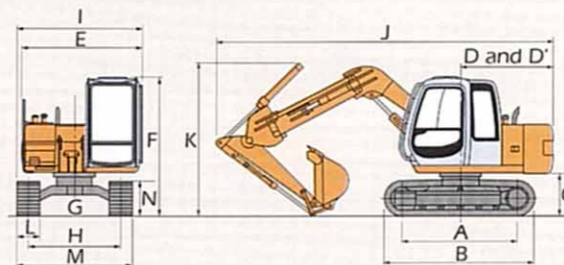

	EX60-s/EX60LC-s with Off-set front	
	STD	LC
A Distance between tumbler	2 140 mm (7'0")	2 290 mm (7'6")
B Undercarriage length	2 765 mm (8'10")	2 920 mm (9'7")
*C Counterweight clearance	760 mm (2'6")	
D Rear-end swing radius	1 750 mm (5'9")	
D' Rear-end length	1 750 mm (5'9")	
E Overall width of upperstructure	2 255 mm (7'5")	
F Overall height of cab	2 570 mm (8'5")	
*G Min. ground clearance	360 mm (1'2")	
H Track gauge	STD 1 750 mm (5'9")	LC 1 850 mm (6'1")
I Overall width	STD 2 340 mm (7'8")	LC 2 390 mm (7'10")
J Overall length		
With 1.62 m (5'4") arm	6 200 mm (20'4")	
K Overall height of boom		
With 1.62 m (5'4") arm	2 810 mm (9'3")	
L Track shoe width	G: 450 mm (18")	G: 600 mm (24")
M Undercarriage width	STD 2 200 mm (7'3")	LC 2 350 mm (7'9")
N Track height	670 mm (2'2") with triple grouser shoe	

\*Excluding track shoe lug.

G: Triple grouser shoe

## WORKING RANGES

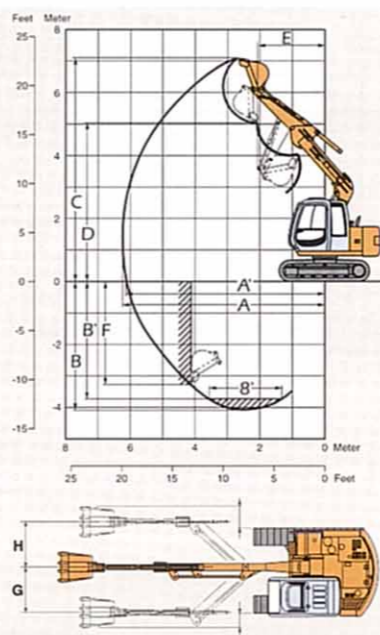

Arm length	EX60-s/EX60LC-s with Off-set front	
	0 m	1.62 m (5'4")
Off-set distance	0 m	Max.
A Max. digging reach	6 310 mm (20'8")	5 860 mm (19'3")
A' Max. digging reach (on ground)	6 160 mm (20'3")	5 690 mm (18'8")
B Max. digging depth	4 150 mm (13'7")	3 690 mm (12'1")
B' Max. digging depth (8' level)	3 770 mm (12'4")	3 190 mm (10'6")
C Max. cutting height	7 120 mm (23'4")	6 760 mm (22'2")
D Max. dumping height	5 070 mm (16'8")	4 710 mm (15'5")
E Min. swing radius	2 080 mm (6'10")	* 2 140 mm / 2 220 mm (7'0") / (7'3")
F Max. vertical wall	3 330 mm (10'11")	2 900 mm (9'6")
G Left side off-set distance	—	1 235 mm (4'1")
H Right side off-set distance	—	1 085 mm (3'7")
Bucket digging force	ISO 55 kN (5 600 kgf, 12 400 lbf)	
	SAE, PCSA 47 kN (4 800 kgf, 10 600 lbf)	
Arm crowd force	ISO 38 kN (3 900 kgf, 8 600 lbf)	
	SAE, PCSA 36 kN (3 700 kgf, 8 200 lbf)	

\*Left/Right side off-set.  
800 kg (1 760 lb) counterweight is required.

## EX60-s/EX60LC-s with Dozer blade (Option)

Equipped with 3.72 m (12'2") boom, 1.62 m (5'4") arm, 450 mm (18") triple grouser shoe and 0.28 m (0.37 yd) PCSA heaped for EX60-s, 0.34 m (0.44 yd) PCSA heaped for EX60LC-s bucket.  
Operating weight: STD: 6 830 kg (15 100 lb)  
LC: 6 920 kg (15 300 lb)

Ground pressure: STD: 31.4 kPa (0.32 kgf/cm<sup>2</sup>, 4.55 psi)  
LC: 30.4 kPa (0.31 kgf/cm<sup>2</sup>, 4.41 psi)

A Overall width of blade: 2 300 mm (7'7")  
B Overall height of blade: 420 mm (1'5")  
C Blade distance: 2 000 mm (6'7")  
D Max. raising height above ground: 425 mm (16.7")  
E Max. lowering depth from ground: 290 mm (11.4")  
F Overall width: 2 390 mm (7'10")

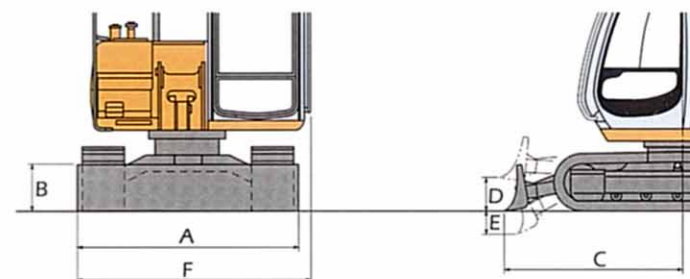

# LIFTING CAPACITIES

## METRIC MEASURE

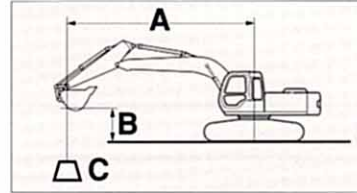

A: Load radius  
B: Load point height  
C: Lifting capacity

Rating over-side or 360 degrees Rating over-front Unit: 1 000 kg

### EX60-s

Conditions	Load point height	Load radius								At max.reach				
		2 m		3 m		4 m		5 m		6 m		At max.reach		@ m
Boom 3.72 m Arm 1.62 m Bucket PCSA: 0.28 m <sup>3</sup> (0.37 yd <sup>3</sup> ) CECE: 0.25 m <sup>3</sup> Shoes 450 mm	5 m					1.34*	1.34*					0.89*	0.89*	4.88
	4 m			1.29*	1.29*	1.37*	1.37*					0.86*	0.86*	5.51
	3 m			1.76*	1.76*	1.45	1.56*	0.97	1.22			0.72	0.86*	5.87
	2 m			2.12	2.52	1.37	1.72	0.94	1.19			0.67	0.86	6.02
	1 m			2.01	2.60	1.30	1.65	0.91	1.15			0.67	0.85	5.97
	0 (Ground)			1.95	2.53	1.25	1.59	0.88	1.12			0.71	0.91	5.72
	-1 m	3.40*	3.40*	1.93	2.51	1.23	1.57	0.87	1.11			0.82	1.04	5.24
	-2 m	4.21*	4.21*	1.95	2.53	1.23	1.58					1.08	1.38	4.42
	-3 m	3.29*	3.29*	2.01	2.44*									
Boom 3.72 m Arm 2.12 m Bucket PCSA: 0.28 m <sup>3</sup> (0.37 yd <sup>3</sup> ) CECE: 0.25 m <sup>3</sup> Shoes 450 mm	5 m					1.09*	1.09*					0.81*	0.81*	5.49
	4 m					1.11*	1.11*	1.02	1.24			0.72	0.78*	6.05
	3 m			1.36*	1.36*	1.32*	1.32*	1.00	1.25			0.63	0.78*	6.37
	2 m			2.10*	2.10*	1.41	1.66*	0.97	1.21	0.63	0.88	0.59	0.76	6.51
	1 m			2.07	2.66	1.33	1.68	0.92	1.17	0.67	0.86	0.58	0.75	6.46
	0 (Ground)			1.96	2.56	1.26	1.61	0.89	1.13	0.65	0.84	0.61	0.79	6.24
	-1 m	2.90*	2.90*	1.92	2.50	1.22	1.57	0.86	1.11			0.69	0.88	5.80
	-2 m	3.90	4.71*	1.92	2.50	1.22	1.56	0.86	1.11			0.85	1.09	5.10
	-3 m	3.98*	3.98*	1.96	2.54	1.24	1.59							

Notes: 1. Ratings are based on SAE J1097.  
2. Lifting capacity of the EX Series does not exceed 75% of tipping load with the machine on firm, level ground or 87% of full hydraulic capacity.  
3. The load point is a hook (not standard equipment) loaded on the back of the bucket.  
4. \*Indicates load limited by hydraulic capacity.

## METRIC MEASURE

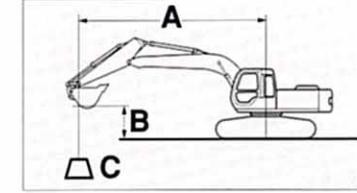

A: Load radius  
B: Load point height  
C: Lifting capacity

Rating over-side or 360 degrees Rating over-front Unit: 1 000 kg

### EX60LC-s

Conditions	Load point height	Load radius								At max.reach				
		2 m		3 m		4 m		5 m		6 m		At max.reach		@ m
Boom 3.72 m Arm 1.62 m Bucket PCSA: 0.34 m <sup>3</sup> (0.44 yd <sup>3</sup> ) CECE: 0.30 m <sup>3</sup> Shoes 450 mm	5 m											0.88*	0.88*	4.88
	4 m			1.28*	1.28*	1.32*	1.32*					0.84*	0.84*	5.51
	3 m			1.74*	1.74*	1.35*	1.35*	1.09	1.48*			0.81	0.84*	5.87
	2 m			2.40	2.50*	1.54*	1.54*	1.06	1.46			0.76	0.87*	6.02
	1 m			2.25	3.16*	1.53	1.86	1.02	1.42			0.75	0.94*	5.97
	0 (Ground)			2.18	3.15	1.45	2.03	0.99	1.39			0.80	1.05*	5.72
	-1 m	3.37*	3.37*	2.17	3.14	1.40	1.97	0.98	1.38			0.92	1.24*	5.24
	-2 m	4.20*	4.20*	2.18	3.08*	1.38	1.95					1.22	1.62*	4.42
	-3 m	3.28*	3.28*	2.24	2.42*	1.39	1.95							
Boom 3.72 m Arm 2.12 m Bucket PCSA: 0.28 m <sup>3</sup> (0.37 yd <sup>3</sup> ) CECE: 0.25 m <sup>3</sup> Shoes 450 mm	5 m					1.08*	1.08*					0.80*	0.80*	5.49
	4 m					1.10*	1.10*	1.13	1.23*			0.76*	0.76*	6.05
	3 m			1.35*	1.35*	1.30*	1.30*	1.12	1.29*			0.71	0.76*	6.37
	2 m			2.08*	2.08*	1.56	1.49*	1.08	1.45*	0.77	1.08	0.67	0.78*	6.51
	1 m			2.31	2.84*	1.48	2.02	1.04	1.44	0.76	1.06	0.66	0.84*	6.46
	0 (Ground)			2.20	3.17	1.41	1.98	1.00	1.40	0.74	1.04	0.69	0.92*	6.24
	-1 m	2.96*	2.96*	2.16	3.12	1.38	1.94	0.98	1.37			0.78	1.07*	5.80
	-2 m	4.44	4.69*	2.16	3.12	1.37	1.94	0.98	1.37			0.96	1.34*	5.10
	-3 m	3.96*	3.96*	2.19	2.83*	1.40	1.96							

Notes: 1. Ratings are based on SAE J1097.  
2. Lifting capacity of the EX Series does not exceed 75% of tipping load with the machine on firm, level ground or 87% of full hydraulic capacity.  
3. The load point is a hook (not standard equipment) loaded on the back of the bucket.  
4. \*Indicates load limited by hydraulic capacity.

METRIC MEASURE

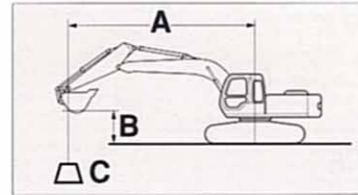

A: Load radius  
B: Load point height  
C: Lifting capacity

EX60-s with Rubber crawler

Rating over-side or 360 degrees Rating over-front Unit: 1 000 kg

Conditions	Load point height	Load radius										At max.reach		
		2 m		3 m		4 m		5 m		6 m				@ m
Boom 3.72 m Arm 1.62 m Bucket PCSA: 0.28 m <sup>3</sup> (0.37 yd <sup>3</sup> ) CECE: 0.25 m <sup>3</sup> Shoes 450 mm	5 m					1.34*	1.34*					0.89*	0.89*	4.88
	4 m			1.29*	1.29*	1.37*	1.37*					0.81	0.85*	5.51
	3 m			1.75*	1.75*	1.40	1.55*					0.70	0.85*	5.87
	2 m			2.11	2.51*	1.33	1.69	0.94	1.19			0.65	0.84	6.02
	1 m			1.95	2.54	1.26	1.61	0.91	1.16			0.64	0.83	5.97
	0 (Ground)			1.88	2.47	1.20	1.56	0.87	1.13			0.68	0.88	5.72
	-1 m	3.39*	3.39*	1.87	2.46	1.18	1.54	0.85	1.10			0.78	1.02	5.24
	-2 m	3.95	4.21*	1.89	2.47	1.19	1.54	0.83	1.08			1.05	1.35	4.42
	-3 m	3.29*	3.29*	1.94	2.43*									
	Boom 3.72 m Arm 2.12 m Bucket PCSA: 0.28 m <sup>3</sup> (0.37 yd <sup>3</sup> ) CECE: 0.25 m <sup>3</sup> Shoes 450 mm	5 m					1.08*	1.08*					0.80*	0.80*
4 m						1.10*	1.10*	0.98	1.23*			0.68	0.77*	6.05
3 m				1.35*	1.35*	1.30*	1.30*	0.96	1.22			0.59	0.77*	6.37
2 m				2.08*	2.08*	1.36	1.64*	0.92	1.18	0.65	0.84	0.55	0.73	6.51
1 m				1.99	2.59	1.27	1.63	0.88	1.13	0.63	0.82	0.55	0.72	6.46
0 (Ground)				1.88	2.47	1.20	1.56	0.84	1.09	0.61	0.81	0.57	0.78	6.24
-1 m		2.97*	2.97*	1.84	2.43	1.17	1.52	0.82	1.07			0.65	0.85	5.80
-2 m		3.84	4.68*	1.84	2.43	1.16	1.51	0.82	1.07			0.81	1.05	5.10
-3 m		3.93	3.95*	1.88	2.47	1.19	1.54							

Notes: 1. Ratings are based on SAE J1097.  
2. Lifting capacity of the EX Series does not exceed 75% of tipping load with the machine on firm, level ground or 87% of full hydraulic capacity.  
3. The load point is a hook (not standard equipment) loaded on the back of the bucket.  
4. \*Indicates load limited by hydraulic capacity.

METRIC MEASURE

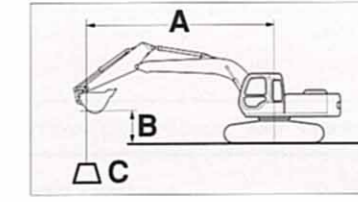

A: Load radius  
B: Load point height  
C: Lifting capacity

EX60LC-s with Rubber crawler

Rating over-side or 360 degrees Rating over-front Unit: 1 000 kg

Conditions	Load point height	Load radius										At max.reach		
		2 m		3 m		4 m		5 m		6 m				@ m
Boom 3.72 m Arm 1.62 m Bucket PCSA: 0.34 m <sup>3</sup> (0.44 yd <sup>3</sup> ) CECE: 0.30 m <sup>3</sup> Shoes 450 mm	5 m					1.34*	1.34*					0.89*	0.89*	4.88
	4 m			1.29*	1.29*	1.37*	1.37*					0.85*	0.85*	5.51
	3 m			1.75*	1.75*	1.53	1.55*	1.03	1.33			0.77	0.85*	5.87
	2 m			2.31	2.51*	1.45	1.87*	1.00	1.30			0.71	0.89	6.02
	1 m			2.15	2.89	1.38	1.81	0.96	1.26			0.71	0.94*	5.97
	0 (Ground)			2.08	2.81	1.33	1.75	0.93	1.23			0.75	0.99	5.72
	-1 m	3.39*	3.39*	2.07	2.80	1.30	1.73	0.92	1.22			0.86	1.14	5.24
	-2 m	4.21*	4.21*	2.09	2.81	1.31	1.74					1.15	1.51	4.42
	-3 m	3.29*	3.29*	2.14	2.43									
	Boom 3.72 m Arm 2.12 m Bucket PCSA: 0.28 m <sup>3</sup> (0.37 yd <sup>3</sup> ) CECE: 0.25 m <sup>3</sup> Shoes 450 mm	5 m					1.08*	1.08*					0.80*	0.80*
4 m						1.10*	1.10*	1.07	1.23*			0.75	0.77*	6.05
3 m				1.35*	1.35*	1.30*	1.30*	1.05	1.29*			0.66	0.77*	6.37
2 m				2.08*	2.08*	1.48	1.64*	1.01	1.31	0.72	0.95	0.79*	0.79*	6.51
1 m				2.20	2.83*	1.39	1.83	0.97	1.27	0.70	0.93	0.61	0.81	6.46
0 (Ground)				2.08	2.81	1.33	1.75	0.93	1.23	0.68	0.91	0.64	0.85	6.24
-1 m		2.97*	2.97*	2.04	2.77	1.29	1.71	0.90	1.20			0.72	0.96	5.80
-2 m		4.33	4.68*	2.04	2.77	1.28	1.71	0.90	1.20			0.89	1.18	5.10
-3 m		3.95*	3.95*	2.08	2.81	1.31	1.74							

Notes: 1. Ratings are based on SAE J1097.  
2. Lifting capacity of the EX Series does not exceed 75% of tipping load with the machine on firm, level ground or 87% of full hydraulic capacity.  
3. The load point is a hook (not standard equipment) loaded on the back of the bucket.  
4. \*Indicates load limited by hydraulic capacity.

**METRIC MEASURE**

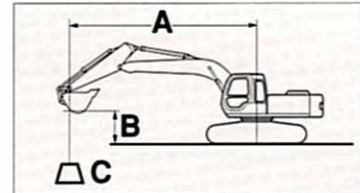

**A: Load radius**  
**B: Load point height**  
**C: Lifting capacity**

**EX60-s Off-set front with Dozer blade(not on ground)**

Rating over-side or 360 degrees Rating over-front Unit: 1 000 kg

Conditions	Load point height	Load radius								At max.reach				
		2 m		3 m		4 m		5 m		6 m				@ m
Boom 3.72 m Arm 1.62 m Bucket PCSA: 0.28 m³ (0.37 yd³) CECE: 0.25 m³ Shoes 450 mm	5 m			1.22*	1.22*							1.14	1.18*	4.87
	4 m			1.27*	1.27*	1.27*	1.27*					0.85	0.97	5.51
	3 m			1.62*	1.62*	1.40*	1.40*	1.00	1.14			0.71	0.81	5.87
	2 m					1.43	1.63	0.95	1.08			0.63	0.73	6.02
	1 m					1.28	1.48	0.88	1.01			0.61	0.71	5.98
	0 (Ground)					1.17	1.37	0.82	0.95			0.64	0.74	5.73
	-1 m			1.78	2.12	1.13	1.32	0.79	0.92			0.74	0.86	5.25
	-2 m	3.56*	3.56*	1.81	2.15	1.13	1.32					1.01	1.17	4.44
	-3 m	2.81*	2.81*	1.91	2.13*									

**EX60LC-s Off-set front with Dozer blade(not on ground)**

Conditions	Load point height	Load radius								At max.reach				
		2 m		3 m		4 m		5 m		6 m				@ m
Boom 3.72 m Arm 1.62 m Bucket PCSA: 0.28 m³ (0.37 yd³) CECE: 0.25 m³ Shoes 450 mm	5 m			1.22*	1.22*							1.18*	1.18*	4.87
	4 m			1.27*	1.27*	1.27*	1.27*					0.94	1.10	5.51
	3 m			1.62*	1.62*	1.40*	1.40*	1.10	1.29			0.79	0.93	5.87
	2 m					1.57	1.65*	1.05	1.23			0.71	0.85	6.02
	1 m					1.42	1.69	0.98	1.16			0.69	0.82	5.98
	0 (Ground)					1.31	1.58	0.92	1.10			0.72	0.87	5.73
	-1 m			2.00	2.48	1.26	1.53	0.89	1.07			0.83	1.00	5.25
	-2 m	3.56*	3.56*	2.03	2.51	1.27	1.53					1.13	1.35	4.44
	-3 m	2.81*	2.81*	2.13*	2.13*									

**Notes:**  
1. Ratings are based on SAE J1097.  
2. Lifting capacity of the EX Series does not exceed 75% of tipping load with the machine on firm, level ground or 87% of full hydraulic capacity.  
3. The load point is a hook (not standard equipment) loaded on the back of the bucket.  
4. \*Indicates load limited by hydraulic capacity.

**STANDARD EQUIPMENT** Standard equipment may vary by country, so please consult your Hitachi dealer for details.

**ENGINE**

- E mode control
- 25 A alternator
- Dry-type air filter with evacuator valve
- Cartridge-type engine oil filter
- Cartridge type fuel filter
- Radiator and oil cooler with dust protective net
- Radiator reserve tank
- Isolation-mounted engine
- Auto-idling system

**HYDRAULIC SYSTEM**

- ETS
- E-P control system (power mode selector)
- OHS
- Quick warm-up system for pilot circuit
- Shockless valve in pilot circuit
- Swing cushion valve in swing circuit
- Travel cushion valve in travel circuit

- Control valve with main relief valve
- Extra port for control valve
- Suction filter
- Full-flow filter
- Pilot filter

**CAB**

All-weather sound-suppressed steel cab. Reinforced tinted (bronze color) glass windows. 6 fluid-filled elastic mounts. Openable front window-upper, lower and left side windows. Intermittent windshield retractable wiper. Adjustable reclining vinylcovered seat. Footrest. Auto-idle switch. Seat belt. Floor mat. Heater. Pilot control shut-off lever.

**MONITOR SYSTEM**

- Meters: Hourmeter. Engine coolant temperature gauge. Fuel meter.
- Warning lamps: Alternator charge. Engine oil pressure. Engine overheat. Air cleaner clog.
- Pilot lamps: Engine preheat.
- Alarm buzzers: Engine oil pressure. Engine overheat.

**LIGHTS**

- 2 working lights

**UPPERSTRUCTURE**

- Undercover
- 700 kg (1 540 lb) counterweight
- Fuel level float
- Hydraulic oil level gauge
- Tool box
- Swing parking brake

**UNDERCARRIAGE**

- Travel parking brake
- Travel motor covers
- Hydraulic track adjuster
- Bolt-on sprocket
- Upper rollers and lower rollers
- Reinforced track links with pin seals
- 450 mm (18") triple grouser shoes

**FRONT ATTACHMENTS**

- Bucket clearance adjust mechanism
- Monolithically cast bucket link A
- Dirt seals on all bucket pins
- 1.62 m (5'4") arm
- 0.28m³ (0.37 yd³) PCSA heaped bucket

**MISCELLANEOUS**

- Standard tool kit
- Lockable machine covers
- Fuel filling cap
- Skid-resistant tapes and handrails.

**OPTIONAL EQUIPMENT** Optional equipment may vary by country, so please consult your Hitachi dealer for details.

- Cooler
- Adjustable reclining clothcovered seat
- AM-FM radio
- Hose rupture valves
- Electric fuel refilling pump
- Swing motion alarm device with lamp
- Travel motion alarm device
- Additional pump
- Piping kit for extra valve port

- PTO/additional valve with piping kit (For standard pump only) (Not for optional blade)
- Pre-cleaner
- Front glass lower guard
- Slope-finishing blade for slope finishing jobs...scraping up or down, compacting, leveling, grading etc.
- Dozer blade
- V-shape bucket 0.20m³ (0.26 yd³) CECE heaped



© **Hitachi Construction Machinery Co., Ltd.**

Head office: Nippon Bldg., 6-2, 2-chome, Ohtemachi,  
Chiyoda-ku, Tokyo 100, Japan

Telephone : Tokyo (03) 3245-6390

Facsimile : Tokyo (03) 3246-2609

KS-E232P

These specifications are subject to change without notice.

Illustrations and photos show the standard models, and may or may not include optional equipment, accessories, and all standard equipment.

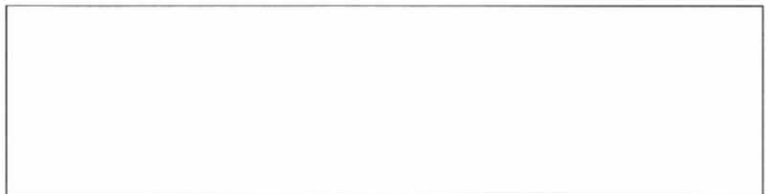

Printed in Japan '97, 12 (SK/CS, HT-)